

Serie leggera - *Lightweight series*

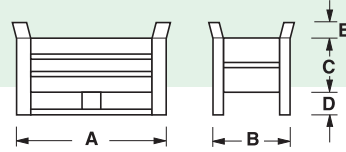

Slitta lato lungo  
Skid long side



Modello Model	Dimensioni • Dimensions					Portata kg Capacity kg
	A	B	C	D	E	
SL 1-8	655	335	230	100	50	400

PORTASCHEDA SALDATO,  
APERTURA SUL LATO  
WELDED CARD HOLDER,  
OPEN AT THE SIDE



ACCESSORI - ACCESSORIES  
PAG. 44



Slitta lato lungo  
Skid long side

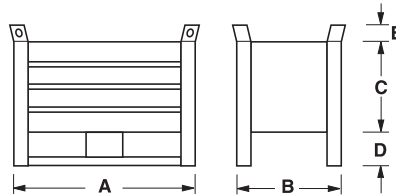

Modello Model	Dimensioni • Dimensions					Portata kg Capacity kg
	A	B	C	D	E	
SL 1-4	800	460	400	150	65	800



Porta in lamiera  
Sheet-metal door

Piede scatolato - Boxed foot



Porta in rete  
Mesh door

Piede scatolato - Boxed foot

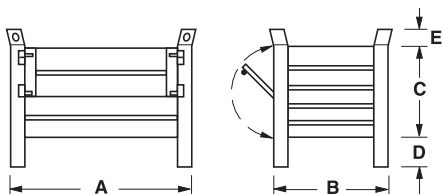

Modello Model	Dimensioni • Dimensions					Portata kg Capacity kg
	A	B	C	D	E	
SL 012	800	500	500	130	65	600

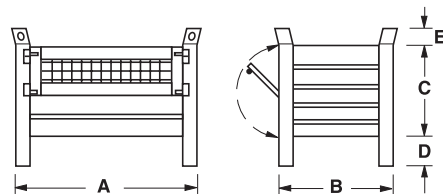

Modello Model	Dimensioni • Dimensions					Portata kg Capacity kg
	A	B	C	D	E	
SL 013	800	500	500	130	65	600

Serie leggera - *Lightweight series*

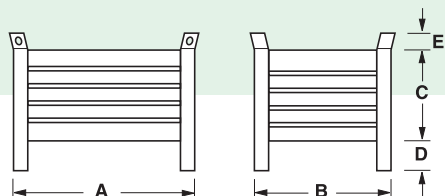

Modello Model	Dimensioni • Dimensions					Portata kg Capacity kg
	A	B	C	D	E	
SL 090	800	500	500	130	65	600
SL 010	800	600	410	130	65	600
SL 009	800	600	500	130	65	600

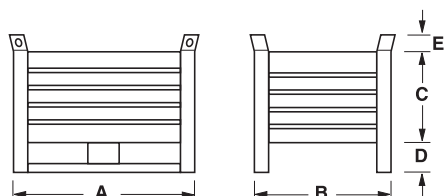

Modello Model	Dimensioni • Dimensions					Portata kg Capacity kg
	A	B	C	D	E	
SL 014	800	500	500	130	65	800
SL 015	800	600	410	130	65	800
SL 016	800	600	500	130	65	800



Modello Model	Dimensioni • Dimensions					Portata kg Capacity kg
	A	B	C	D	E	
SL 082	700	650	450	150	65	700
SL 091	800	500	500	130	65	700
SL 092	800	600	410	130	65	700
SL 093	800	600	500	130	65	700

Modello Model	Dimensioni • Dimensions					Portata kg Capacity kg
	A	B	C	D	E	
SL 094	800	500	500	130	65	700
SL 095	800	600	410	130	65	700
SL 096	800	600	500	130	65	700
SL 026	1000	800	450	130	65	1000

Serie speciali - Special series

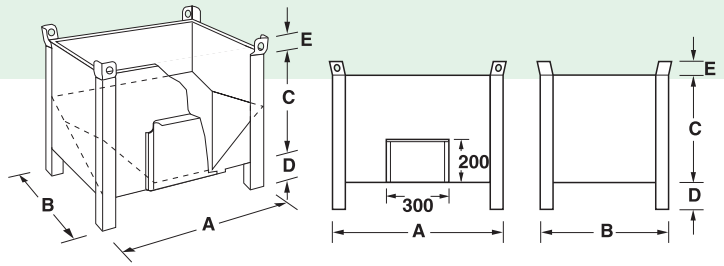

Modello Model	Dimensioni • Dimensions					Portata kg Capacity kg
	A	B	C	D	E	
SL 097	800	600	500	130	65	700

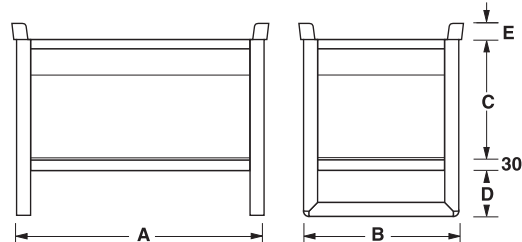

Modello Model	Dimensioni • Dimensions					Portata kg Capacity kg
	A	B	C	D	E	
SL 191	800	500	400	150	45	1000

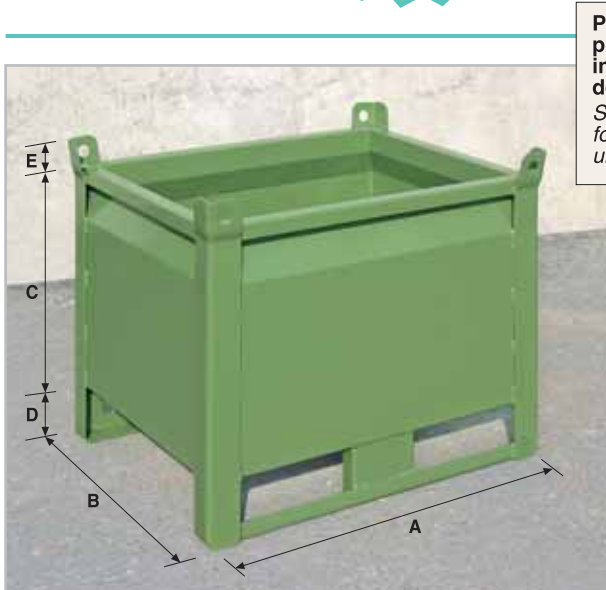

Modello Model	Dimensioni • Dimensions					Portata kg Capacity kg
	A	B	C	D	E	
SL 192	800	600	500	130	65	800

**A richiesta sono disponibili - The following are available on request**



A bocca di lupo - Raking mouth

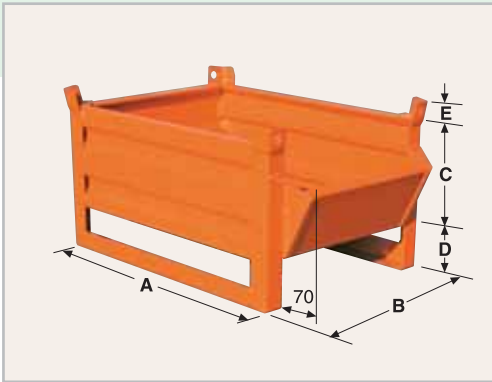

Composizione realizzata con il modello SL 201  
Composition made with model SL 201



Modello Model	Dimensioni • Dimensions					Portata kg Capacity kg
	A	B	C	D	E	
SL 201	630	450	230	100	40	500

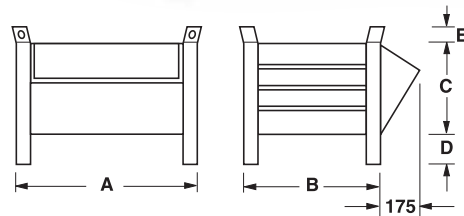

Modello Model	Dimensioni • Dimensions					Portata kg Capacity kg
	A	B	C	D	E	
SL 011	800	600	410	130	65	600

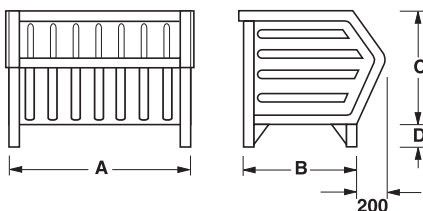

Modello Model	Dimensioni • Dimensions				Portata kg Capacity kg
	A	B	C	D	
SL 130	800	500	500	100	1000

A bocca di lupo - Raking mouth

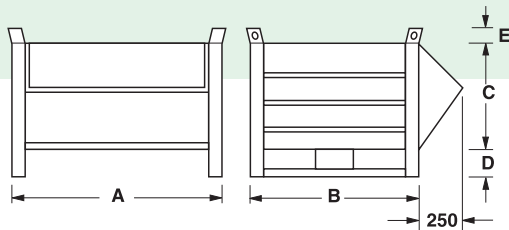

Modello Model	Dimensioni • Dimensions					Portata kg Capacity kg
	A	B	C	D	E	
SL 018	1000	800	500	130	65	1000
SL 083	1000	800	650	130	65	1000
SL 084	1200	800	650	130	65	1000



ETICHETTATURA AUTOADESIVA  
CON TARA AD ETTOGRAMMO  
SELF-ADHESIVE LABELLING WITH  
TARE IN HECTOGRAMS

TARA 112.4 kg

ACCESSORI - ACCESSORIES  
PAG. 45

Composizione realizzata  
con il modello SL 130  
Composition made with  
model SL 201



SCRITTE STAMPATE IN RILIEVO  
WORDING PRINTED IN RELIEF

PORTATA KG 1000

ACCESSORI - ACCESSORIES PAG. 45

Serie leggera - Lightweight series

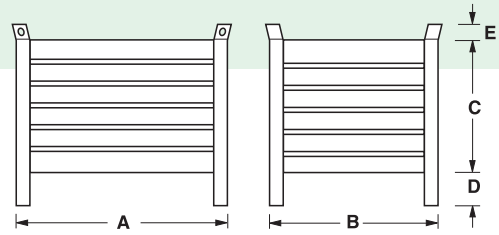

Modello Model	Dimensioni • Dimensions					Portata kg Capacity kg
	A	B	C	D	E	
SL 008	1000	800	410	130	65	800
SL 005	1000	800	500	130	65	800
SL 001	1000	800	650	130	65	800
SL 076	1200	800	650	130	65	800

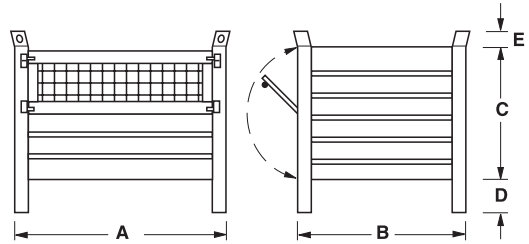
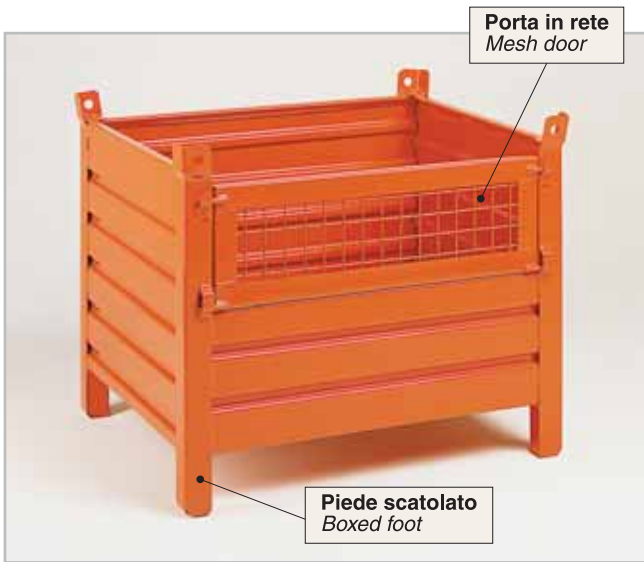

Modello Model	Dimensioni • Dimensions					Portata kg Capacity kg
	A	B	C	D	E	
SL 007	1000	800	500	130	65	800
SL 002	1000	800	650	130	65	800
SL 077	1200	800	650	130	65	800

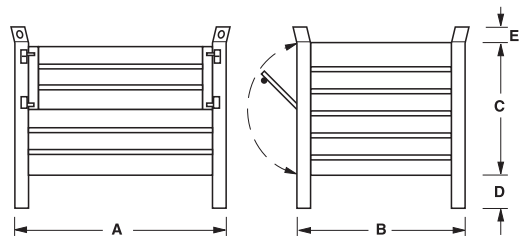
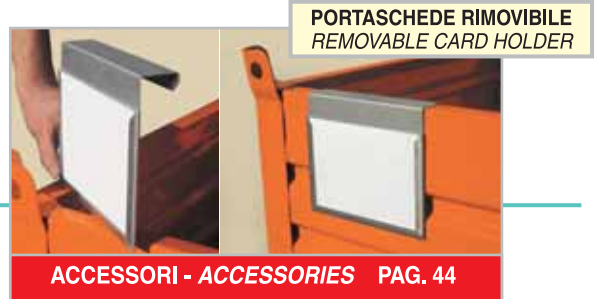

Modello Model	Dimensioni • Dimensions					Portata kg Capacity kg
	A	B	C	D	E	
SL 006	1000	800	500	130	65	800
SL 003	1000	800	650	130	65	800
SL 055	1000	800	800	130	65	800
SL 078	1200	800	650	130	65	800
SL 057	1200	800	800	130	65	800

Serie media - Medium duty series

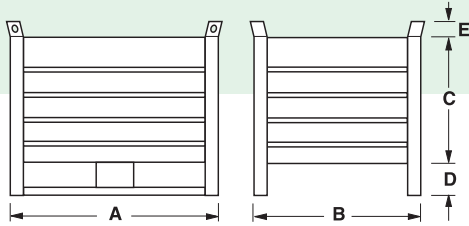

Modello Model	Dimensioni • Dimensions					Portata kg Capacity kg
	A	B	C	D	E	
SL 021	1000	800	500	130	65	1000
SL 025	1000	800	650	130	65	1000
SL 027	1200	800	650	130	65	1000
SL 079	1200	1000	650	130	65	1000



Slitta lato lungo - Skid long side



TELAIO CON RUOTE PER MOVIMENTAZIONE CONTENITORI  
FRAME ON WHEELS FOR CONTAINER HANDLING

TELAIO CON RUOTE - FRAME ON WHEELS PAG. 27

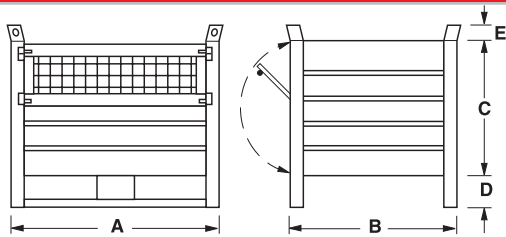

Modello Model	Dimensioni • Dimensions					Portata kg Capacity kg
	A	B	C	D	E	
SL 019	1000	800	500	130	65	1000
SL 023	1000	800	650	130	65	1000
SL 029	1200	800	650	130	65	1000
SL 080	1200	1000	650	130	65	1000



Porta in rete  
Mesh door

Slitta lato lungo - Skid long side

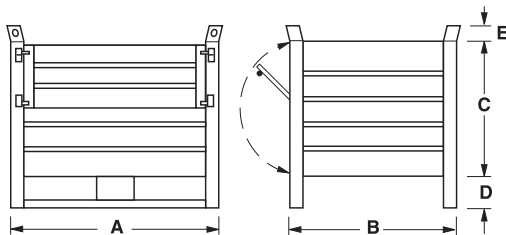

Modello Model	Dimensioni • Dimensions					Portata kg Capacity kg
	A	B	C	D	E	
SL 020	1000	800	500	130	65	1000
SL 024	1000	800	650	130	65	1000
SL 059	1000	800	800	130	65	1000
SL 028	1200	800	650	130	65	1000
SL 067	1200	800	800	130	65	1000
SL 081	1200	1000	650	130	65	1000
SL 168	1200	1000	800	130	65	1000



Porta in lamiera  
Sheet-metal door

Slitta lato lungo - Skid long side

Serie media con telaio - *Medium duty series with frame*

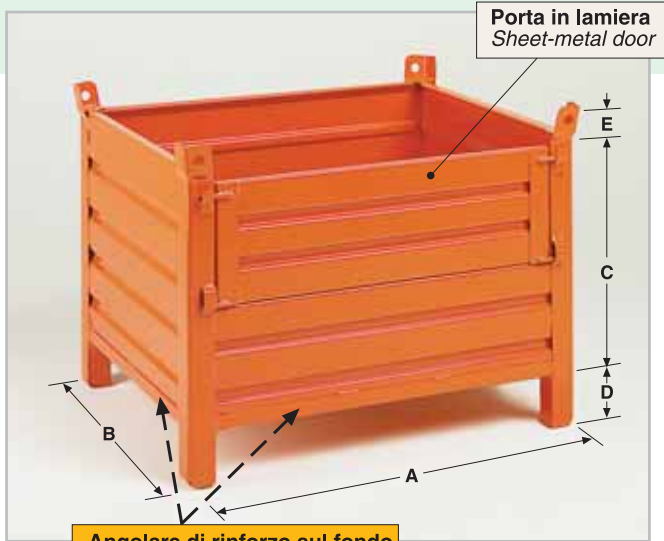

Angolare di rinforzo sul fondo  
*Strengthening frame on bottom*

Modello <i>Model</i>	Dimensioni • <i>Dimensions</i>					Portata kg <i>Capacity kg</i>
	A	B	C	D	E	
SL 004	1000	800	600	130	65	1000



Angolare di rinforzo sul fondo  
*Strengthening frame on bottom*

Modello <i>Model</i>	Dimensioni • <i>Dimensions</i>					Portata kg <i>Capacity kg</i>
	A	B	C	D	E	
SL 022	1000	800	600	130	65	1000

Apertura porta con scorrimento a ghigliottina,  
per un migliore utilizzo del contenitore in spazi ridotti



PER SPAZI  
RIDOTTI  
WHEN SPACE  
IS LIMITED

Slide-up door opening easier to use when space is limited

Serie pesante - Heavy duty series

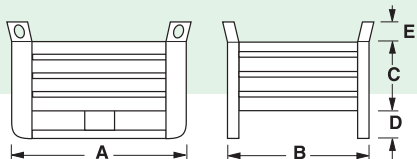

Modello Model	Dimensioni • Dimensions					Portata kg Capacity kg
	A	B	C	D	E	
SL 033 M	1000	800	400	150	110	1500
SL 033 P	1000	800	400	150	110	2000
SL 085 M	1200	800	400	150	110	1500
SL 085 P	1200	800	400	150	110	2000

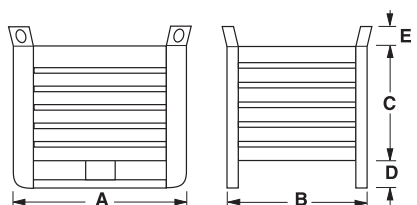

Modello Model	Dimensioni • Dimensions					Portata kg Capacity kg
	A	B	C	D	E	
SL 086	1000	800	520	150	110	1500
SL 032 M	1000	800	650	150	110	1500
SL 032 P	1000	800	650	150	110	2000
SL 031 M	1200	800	650	150	110	1500
SL 031 P	1200	800	650	150	110	2000
SL 087	1200	1000	650	150	110	1500
SL 088	1300	1000	700	150	110	1500



Porta sul lato corto  
Door on short side



Modello Model	Dimensioni • Dimensions					Portata kg Capacity kg
	A	B	C	D	E	
SL 098	1000	800	650	150	110	1500
SL 099	1200	800	650	150	110	1500

Porta sul lato lungo  
Door on long side



Modello Model	Dimensioni • Dimensions					Portata kg Capacity kg
	A	B	C	D	E	
SL 198	1000	800	650	150	110	1500
SL 199	1200	800	650	150	110	1500

Serie pesante - Heavy duty series

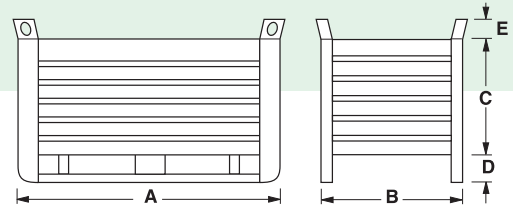

Modello Model	Dimensioni • Dimensions					Portata kg Capacity kg
	A	B	C	D	E	
SL 030 M	1500	800	650	150	110	1500
SL 030 P	1500	800	650	150	110	2000
SL 089 M	1500	1000	650	150	110	1500
SL 089 P	1500	1000	650	150	110	2000

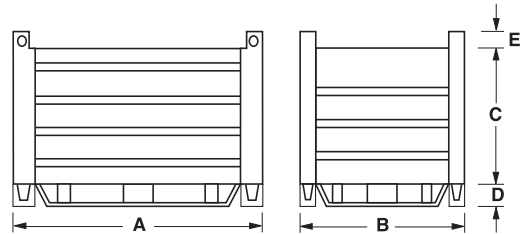

Modello Model	Dimensioni • Dimensions					Portata kg Capacity kg
	A	B	C	D	E	
SL 407 M	1100	725	600	100	80	1500
SL 407 P	1100	725	600	100	80	2000
SL 406 M	1450	1100	600	100	80	1500
SL 406 P	1450	1100	600	100	80	2000



Coperchio incernierato  
Hinged lid



Modello Model	Dimensioni • Dimensions					Portata Kg Capacity Kg
	A	B	C	D	E	
SL 9283	2000	1000	1000	130	65	1000